

iDS-2CD7586G0-IZHS(Y) 8 MP IR Varifocal Dome Network Camera

DarkFighter

DeepinView^{series}



Hikvision has been dedicated to develop products with security since established. Hikvision always follows security by design principle and has adopted many methods of security technologies into our product development lifecycle, including terminal security, data security, application security, network security, and privacy protection. In the meantime, the security technologies used by Hikvision are all in compliance with local applicable laws and safety regulations. These security measures could enhance product's cyber security protection capability and protect your devices as well as your data from malicious cyber attacks.

- High quality imaging with 8 MP resolution
- Excellent low-light performance via DarkFighter technology
- Efficient H.265+ compression technology to save bandwidth and storage
- Clear imaging against strong back light due to 120 dB true WDR technology
- 5 streams to meet a wide variety of applications
- Water and dust resistant (IP67) and vandal proof (IK10)
- Anti-IR reflection bubble guarantees image quality

▪ Function

Face Capture

With embedded deep learning based algorithms, the camera is able to give the best shot of a target face through detecting, capturing, grading and selecting. The camera uses face exposure function to dynamically adjust face area exposure of captures and ensures high face picture quality.

Perimeter Protection

With embedded deep learning based target detection and classification algorithms, the camera carries out the duty of perimeter protection, monitoring the actions of line crossing, intrusion, region entrance, and region exiting. The algorithms greatly filter out the mistaken alarm caused by the interference of leaves, lights, animal, flag, etc.

Multi-Target-Type Detection

With the embedded deep learning algorithms, the camera detects and captures the face, human body, vehicle in the specified region.

Queue Management

With embedded deep learning based algorithms, the camera detects queuing-up people number and waiting time of each person. It can generate reports to compare the efficiency of different queuing-ups and display the changing status of one queue, and supports raw data export for further analysis.

Regional People Counting

With the embedded deep learning algorithms, the camera supports people density detection and will upload detection data through scheduled uploading, number of people change uploading and congestion level uploading. It also supports number of people exception detection and waiting time exception detection.

On/Off Duty Detection

With the embedded deep learning algorithms, the camera supports absence detection and on/off duty detection. It can detect the on/off duty status and people number changes in a predefined area.

Heat Map

The camera can generate a graphic description of visits (by calculating amount of people or amount of dwell time) in a configured area.

Multi-Dimension People Counting

With the embedded deep learning algorithms, the camera integrates multiple intelligences. It counts persons and compares them with the built-in face picture library to remove duplicates. It counts persons and reports an alarm simultaneously to achieve both the entrance control and people counting.

Hard Hat Detection

With the embedded deep learning algorithms, the camera detects the persons in the specified region. It detects whether the person is wearing a hard hat, and reports an alarm if not.

▪ Specification

Camera	
Image Sensor	1/1.8" Progressive Scan CMOS
Max. Resolution	3840 × 2160
Min. Illumination	Color: 0.002 Lux @ (F1.2, AGC ON); B/W: 0.0002 Lux @ (F1.2, AGC ON), 0 Lux with IR
Shutter Time	1 s to 1/100,000 s
Day & Night	IR cut filter Blue glass module to reduce ghost phenomenon
Angle Adjustment	Pan: 0° to 355°, tilt: 0° to 75°, rotate: 0° to 355°
Lens	
Focal Length & FOV	2.8 to 12 mm, horizontal FOV: 112.3° to 41.2°, vertical FOV: 58° to 23.1°, diagonal FOV: 137.3° to 47.3° 8 to 32 mm, horizontal FOV: 41.8° to 14.9°, vertical FOV: 22.92° to 8.48°, diagonal FOV: 48.7° to 17°
Focus	Auto,Semi-auto,Manual
Iris Type	P-iris
Aperture	2.8 to 12 mm: F1.2 to F2.5 8 to 32 mm: F1.7 to F1.73
DORI	
DORI	Wide: 2.8 to 12 mm: D (Detect): 87 m, O (Observe): 34.5 m, R (Recognize): 17.4 m, I (Identify): 8.7 m 8 to 32 mm: D (Detect): 218 m, O (Observe): 86.5 m, R (Recognize): 43.6 m, I (Identify): 21.8 m Tele: 2.8 to 12 mm: D (Detect): 216 m, O (Observe): 85.7 m, R (Recognize): 43.2 m, I (Identify): 21.6 m 8 to 32 mm: D (Detect): 580 m, O (Observe): 230.2 m, R (Recognize): 116 m, I (Identify): 58 m
Illuminator	
IR Wavelength	850 nm
Supplement Light Range	2.8 to 12 mm: 30 m 8 to 32 mm: 50 m
Smart Supplement Light	Yes
Supplement Light Type	IR
AI Open Platform	
Model Specification	Up to 4 models, Model type: detection model, classification model, mixed model (detection model and classification model)
Video	
Main Stream	50 Hz: 25 fps (3840 × 2160, 3072 × 1728, 2560 × 1440, 1920 × 1080, 1280 × 720) 60 Hz: 30 fps (3840 × 2160, 3072 × 1728, 2560 × 1440, 1920 × 1080, 1280 × 720)
Sub-Stream	50 Hz: 25 fps (704 × 576, 640 × 480) 60 Hz: 30 fps (704 × 480, 640 × 480)
Third Stream	50 Hz: 25 fps (1920 × 1080, 1280 × 720, 704 × 576, 640 × 480) 60 Hz: 30 fps (1920 × 1080, 1280 × 720, 704 × 480, 640 × 480)

Fourth Stream	50 Hz: 25 fps (704 × 576, 640 × 480) 60 Hz: 30 fps (704 × 480, 640 × 480)
Fifth Stream	50 Hz: 25 fps (704 × 576, 640 × 480) 60 Hz: 30 fps (704 × 480, 640 × 480)
Video Compression	Main stream: H.265+/H.265/H.264+/H.264, Sub-stream: H.265/H.264/MJPEG, Third stream: H.265/H.264, Fourth stream: H.265/H.264/MJPEG, Fifth stream: H.265/H.264/MJPEG
Video Bit Rate	32 Kbps to 16 Mbps
H.264 Type	Baseline Profile,Main Profile,High Profile
H.265 Type	Main Profile
Bit Rate Control	CBR,VBR
Scalable Video Coding (SVC)	H.264 and H.265 encoding
Region of Interest (ROI)	4 fixed regions for each stream
Target Cropping	Yes
Audio	
Audio Type	Mono sound
Audio Compression	G.711/G.722.1/G.726/MP2L2/PCM/MP3/AAC-LC
Audio Bit Rate	64 Kbps (G.711ulaw/G.711alaw)/16 Kbps (G.722.1)/16 Kbps (G.726)/32 to 192 Kbps (MP2L2)/8 to 320 Kbps (MP3)/16 to 64 Kbps (AAC-LC)
Environment Noise Filtering	Yes
Audio Sampling Rate	8 kHz/16 kHz/32 kHz/44.1 kHz/48 kHz
Network	
Protocols	TCP/IP, ICMP, HTTP, HTTPS, FTP, SFTP, SRTP, DHCP, DNS, DDNS, RTP, RTSP, RTCP, PPPoE, NTP,UPnP, SMTP, SNMP, IGMP, 802.1X, QoS, IPv4, IPv6, UDP, Bonjour, SSL/TLS, WebSocket, WebSockets
Simultaneous Live View	Up to 20 channels
API	Open Network Video Interface (Profile S, Profile G, Profile T, Profile M),ISAPI,SDK,ISUP
User/Host	Up to 32 users 3 user levels: administrator, operator, and user
Security	Password protection, complicated password, HTTPS encryption, 802.1X authentication (EAP-TLS, EAP-LEAP, EAP-MD5), watermark, IP address filter, basic and digest authentication for HTTP/HTTPS, WSSE and digest authentication for Open Network Video Interface, RTP/RTSP OVER HTTPS, Control Timeout Settings, Security Audit Log, TLS 1.2, TLS 1.3, TPM 2.0 (FIPS 140-2 level 2), AES128/256
Network Storage	NAS (NFS, SMB/CIFS),Auto Network Replenishment (ANR), Together with high-end Hikvision memory card, memory card encryption and health detection are supported.
Client	iVMS-4200,Hik-Connect,Hik-Central
Web Browser	Plug-in required live view: IE 10, IE 11, Plug-in free live view: Chrome 57.0+, Firefox 52.0+, Edge 89+, Safari 11+, Local service: Chrome 57.0+, Firefox 52.0+, Edge 89+
Image	
Image Parameters Switch	Yes

Image Settings	Saturation,brightness,contrast,sharpness,white balance,AGC,adjustable by client software or web browser
Day/Night Switch	Day,Night,Auto,Schedule,Alarm Trigger
Wide Dynamic Range (WDR)	120 dB
SNR	≥ 52 dB
Privacy Mask	8 programmable polygon privacy masks
Image Enhancement	BLC,HLC,3D DNR,Defog
Picture Overlay	LOGO picture can be overlaid on video with 128 × 128 24 bit bmp format.
Image Stabilization	EIS
Interface	
Video Output	1 Vp-p Composite Output (75 Ω/CVBS) (Only for debugging)
Ethernet Interface	1 RJ45 10 M/100 M/1000 M self-adaptive Ethernet port
On-Board Storage	Built-in memory card slot, support microSD/microSDHC/microSDXC card, up to 1 TB
Audio	1 input (line in), 1 output (line out), 3.5 mm connector
Built-in Microphone	Yes, 2 built-in microphones
Alarm	1 input, 1 output (max. 24 VDC, 1 A)
RS-485	-Y: 1 RS-485 (Half duplex, HIKVISION, Pelco-P, Pelco-D, self-adaptive)
Reset Key	Yes
Power Output	12 VDC, max. 100 mA
Event	
Basic Event	Motion detection (support alarm triggering by specified target types (human and vehicle)),video tampering alarm,exception (network disconnected, IP address conflict, illegal login, abnormal restart, HDD full, HDD error),video quality diagnosis,vibration detection
Smart Event	scene change detection,audio exception detection,defocus detection
Linkage	Upload to FTP/NAS/memory card,notify surveillance center,send email,trigger alarm output,trigger recording,trigger capture,audible warning
Deep Learning Function	
Multi-target-type Detection	Supports simultaneous detection and capture of human body, face, and vehicle, Gets 7 face features, Gets 13 human body features, Gets 2 vehicle features, Supports counting the number of line crossing targets by type, including human body, non-motor vehicle, motor vehicle
Face Capture	Detects up to 120 faces simultaneously, captures up to 40 face pictures per frame simultaneously and uploads up to 10 face pictures per second, Supports swing left and right from -60° to 60°, tilt up and down from -30° to 30°, Uploads face with background and closed-up face pictures, Supports best shot and quick shot for capture mode, Gets 7 face features
Face Comparison	Up to 10 face libraries. 30,000 faces for each library. 150,000 faces in total, Supports face library encryption
Perimeter Protection	Line crossing, intrusion, region entrance, region exiting Support alarm triggering by specified target types (human and vehicle) Support combined event alarm triggering

Heat Map	<p>A graphic description of visits (by calculating amount of people or amount of dwell time) in a configured area.,</p> <p>Two report types are available, space heat map and time heat map line chart.</p>
Queue Management	<p>Supports up to 8 detection regions, and independent arming schedule and linkage method</p> <p>Supports 2 detection modes: regional people queuing-up, waiting time detection</p> <p>Generates reports to compare the efficiency of different queuing-ups and display the changing status of one queue</p> <p>Supports raw data export for further analysis</p> <p>Supports real-time data uploading and scheduled data uploading</p> <p>Regional people queuing-up: supports 4 alarm trigger conditions, including greater than threshold, less than threshold, equal to threshold, not equal to threshold</p> <p>Waiting time detection: supports 1 alarm trigger condition, including greater than threshold</p>
People Counting	<p>Supports Multi-Dimension People Counting,</p> <p>Supports counting, displaying and exporting the people flow data of entering, exiting and passing by (The data is stored in the flash.),</p> <p>Supports real-time uploading and uploading by statistic cycle,</p> <p>Supports generating daily, weekly, monthly or annually reports,</p> <p>Supports dynamic deduplication based on face picture comparison, and can filter out the target with the same custom face pictures, same attributes, or filter out repeated invalid targets within the set time interval,</p> <p>Supports face feature deduplication,</p> <p>Supports people flow data replenishment</p>
Hard Hat Detection	<p>Detects up to 30 human targets simultaneously</p> <p>Supports up to 4 shield regions</p>
Metadata	<p>Intrusion detection,line crossing detection,region entrance detection,region exiting detection,face capture,multi-target-type detection</p>
Regional People Counting	<p>Supports up to 8 detection regions, and independent arming schedule and linkage method</p> <p>Supports 3 detection modes: people density detection, number of people exception detection, waiting time exception detection</p> <p>Supports parameter settings: alarm times per exception, alarm interval, first alarm delay</p> <p>Supports searching real-time number of people</p> <p>People density detection: supports scheduled uploading, number of people change uploading, congestion level uploading</p> <p>Number of people exception detection: supports 6 alarm trigger conditions, including greater than threshold A, less than threshold A, equal to threshold A, not equal to threshold A, greater than threshold A and less than threshold B, less than threshold A or greater than threshold B (threshold A should be less than threshold B)</p> <p>Waiting time exception detection: supports 3 alarm trigger conditions, including greater than threshold A, less than threshold A, greater than threshold A and less than threshold B (threshold A should be less than threshold B)</p>

On/Off Duty Detection	<p>Supports up to 8 detection regions, and independent arming schedule and linkage method</p> <p>Supports 2 detection modes: absence detection, on/off duty detection</p> <p>Supports parameter settings: person on duty, absence duration</p>
General	
Power	<p>With -Y: 12 VDC \pm 20%, 1.23 A, max. 14.7 W, three-core terminal block; 24 VAC \pm 20%, 0.91 A, max. 13.7 W, three-core terminal block; PoE: IEEE 802.3at, Type 2, Class 4, 42.5 V to 57 V, 0.27 A to 0.36 A, max. 15.0 W</p> <p>Without -Y: 12 VDC \pm 20%, 1.23 A, max. 14.7 W, two-core terminal block; 24 VAC \pm 20%, 0.91 A, max. 13.7 W, two-core terminal block; PoE: IEEE 802.3at, Type 2, Class 4, 42.5 V to 57 V, 0.27 A to 0.36 A, max. 15.0 W</p>
Material	Aluminum alloy body
Dimension	\varnothing 162 mm \times 141.8 mm (\varnothing 6.4" \times 5.6")
Package Dimension	251 mm \times 215 mm \times 189 mm (9.9" \times 8.5" \times 7.4")
Weight	<p>Without -Y: approx. 1490 g (3.28 lb.)</p> <p>With -Y: approx. 1565 g (3.45 lb.)</p>
With Package Weight	<p>Without -Y: approx. 2435 g (5.37 lb.)</p> <p>With -Y: approx. 2295 g (5.06 lb.)</p>
Startup and Operating Conditions	-40 °C to 60 °C (-40 °F to 140 °F). Humidity 95% or less (non-condensing)
Storage Conditions	-30 °C to 60 °C (-22 °F to 140 °F). Humidity 95% or less (non-condensing)
Language	33 languages: English, Russian, Estonian, Bulgarian, Hungarian, Greek, German, Italian, Czech, Slovak, French, Polish, Dutch, Portuguese, Spanish, Romanian, Danish, Swedish, Norwegian, Finnish, Croatian, Slovenian, Serbian, Turkish, Korean, Traditional Chinese, Thai, Vietnamese, Japanese, Latvian, Lithuanian, Portuguese (Brazil), Ukrainian
General Function	Heartbeat, mirror, password protection, one-key reset
Heater	Yes
Device Management	Supports adding alarm box (DS-FM2466) in the LAN to expand 6 additional input and 6 output alarm interfaces
Approval	
EMC	<p>FCC: 47 CFR Part 15, Subpart B,</p> <p>CE-EMC: EN 55032: 2015, EN 61000-3-2:2019, EN 61000-3-3: 2013+A1:2019, EN 50130-4: 2011 +A1: 2014,</p> <p>RCM: AS/NZS CISPR 32: 2015,</p> <p>IC: ICES-003: Issue 7,</p> <p>KC: KN32: 2015, KN35: 2015</p>
Safety	<p>UL: UL 62368-1,</p> <p>CB: IEC 62368-1: 2014+A11,</p> <p>CE-LVD: EN 62368-1: 2014/A11: 2017,</p> <p>BIS: IS 13252 (Part 1): 2010/IEC 60950-1: 2005,</p> <p>LOA: IEC/EN 60950-1</p>
Environment	<p>CE-RoHS: 2011/65/EU,</p> <p>WEEE: 2012/19/EU,</p> <p>Reach: Regulation (EC) No 1907/2006</p>
Protection	IP67: IEC 60529-2013, IK10: IEC 62262:2002

Anti-Corrosion Protection	-Y: NEMA 4X (NEMA 250-2018)
Automotive and Railway	EN50121-4
Other	PVC FREE
CC	Common Criteria, Assurance Level: EAL2 + ALC_FLR.2

▪ Typical Application

Hikvision products are classified into three levels according to their anti-corrosion performance. Refer to the following description to choose for your using environment.

-Y model: This model has MODERATE PROTECTION.

Without -Y model: This model has NO SPECIFIC PROTECTION.

Level	Description
Top-level protection	Hikvision products at this level are equipped for use in areas where professional anti-corrosion protection is a must. Typical application scenarios include coastlines, docks, chemical plants, and more.
Moderate protection	Hikvision products at this level are equipped for use in areas with moderate anti-corrosion demands. Typical application scenarios include coastal areas about 2 kilometers (1.24 miles) away from coastlines, as well as areas affected by acid rain.
No specific protection	Hikvision products at this level are equipped for use in areas where no specific anti-corrosion protection is needed.

▪ Available Model

iDS-2CD7586G0-IZHS(2.8-12mm)(C)

iDS-2CD7586G0-IZHS(8-32mm)(C)

iDS-2CD7586G0-IZHSY(2.8-12mm)(C)

iDS-2CD7586G0-IZHSY(8-32mm)(C)

▪ Dimension

Without -Y:

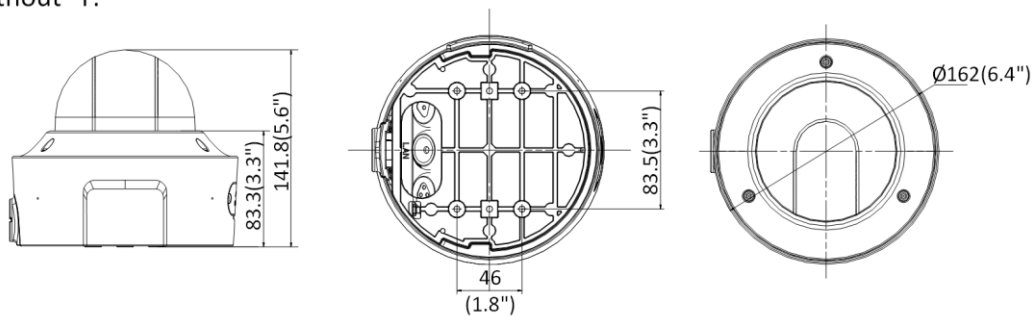



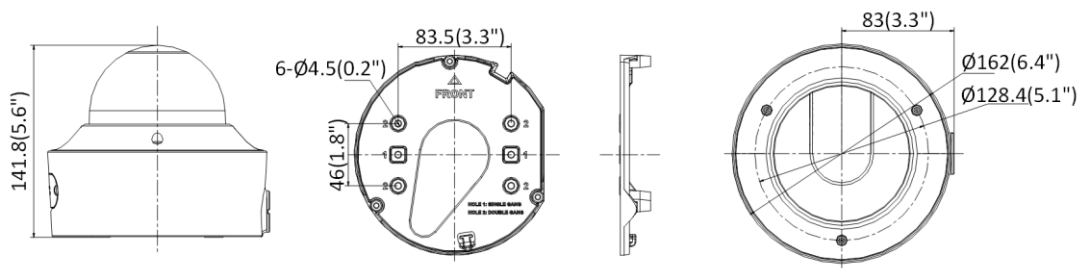







With -Y:



Unit: mm (inch)

▪ Accessory

▪ Optional

DS-1473ZJ-155 Wall mount	DS-1471ZJ-155 Pendant Mount	DS-1475ZJ-SUS Vertical pole mount	DS-1476ZJ-SUS Corner mount	DS-1473ZJ-155B Wall mount
				
DS-1475ZJ-Y Vertical pole mount	DS-1476ZJ-Y Corner mount	DS-1471ZJ-155-Y Pendant Mount	DS-1473ZJ-155-Y Wall mount	DS-1227ZJ-DM42 In-ceiling mount
				

Headquarters

No.555 Qianmo Road, Binjiang District,
Hangzhou 310051, China
T +86-571-8807-5998
www.hikvision.com



Follow us on social media to get the latest product and solution information.

